

Clanlike®

air

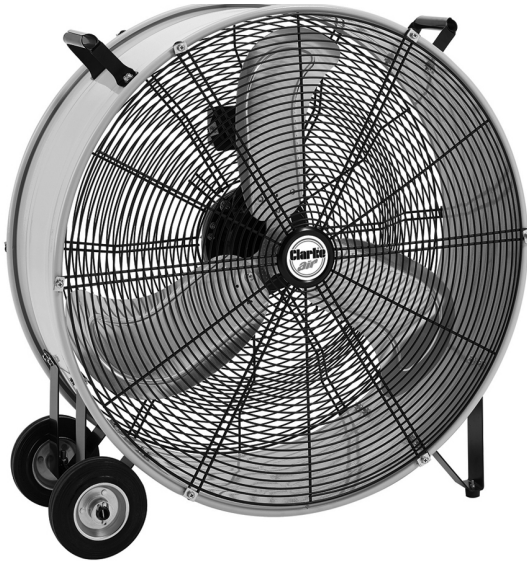

24 INCH DRUM FAN

MODEL NO: CAM24110V

PART NO: 3231564

OPERATION & MAINTENANCE INSTRUCTIONS

UK
CA | CE



ORIGINAL INSTRUCTIONS

GC0521

INTRODUCTION

Thank you for purchasing this CLARKE 24" Drum Fan.

Before attempting to use this product, please read this manual thoroughly and follow the instructions carefully. In doing so you will ensure the safety of yourself and that of others around you, and you can look forward to your purchase giving you long and satisfactory service.

SPECIFICATIONS

MODEL	CAM24110V
Part No:	3231564
Voltage:	110 V~ (50Hz)
Ingress Protection Rating	IP20
Insulation Class	1
Fan Power Input	115.8 W
Duty Cycle	S1 (continuous)
Fan Speeds	
	Position 1 879 rpm
	Position 2 931 rpm
Standby Power Consumption	N/A
Fan Sound Power Level	77 dB(A)
Sound Power Measured	81.3 dB(A) L _{Wα}
Guaranteed Sound Level	83.8 dB L _{Wα}
Maximum Fan Flow Rate	284 m ³ /m
Maximum Air Velocity	2.3 m/sec
Service Value	2.5 m ³ /m/W
Measurement Standard for Service Value	EU 206/2012
Dimensions (D x W x H) mm	675 x 275 x 688
Weight:	16.1 kg

ELECTRICAL CONNECTIONS



WARNING! READ THESE ELECTRICAL SAFETY INSTRUCTIONS THOROUGHLY BEFORE CONNECTING THE PRODUCT TO THE POWER SUPPLY.

Before switching the product on, make sure that the voltage of your electricity supply is the same as that indicated on the rating plate. Connecting it to any other power source may cause damage.

If the plug has to be changed due to damage, a replacement should be fitted, following the wiring instructions shown below. The old plug must be disposed of as insertion into a 110v socket could cause an electrical hazard.



**WARNING: THE WIRES IN THE POWER CABLE OF THIS PRODUCT ARE COLOURED IN ACCORDANCE WITH THE FOLLOWING CODE:
BLUE = NEUTRAL BROWN = LIVE YELLOW =**

If the colours of the wires in the power cable of this product do not correspond with the markings on the terminals of your plug, proceed as follows.

- The **Blue** wire must be connected to the terminal which is marked **N** or **Neutral**.
- The **Brown** wire must be connected to the terminal which is marked **L** or **Live**.
- The **Yellow** wire must be connected to the terminal which is marked **E** or **Earth**.

If in any doubt, consult a qualified electrician. DO NOT attempt any repairs yourself.

Plug must be BS60309 approved.

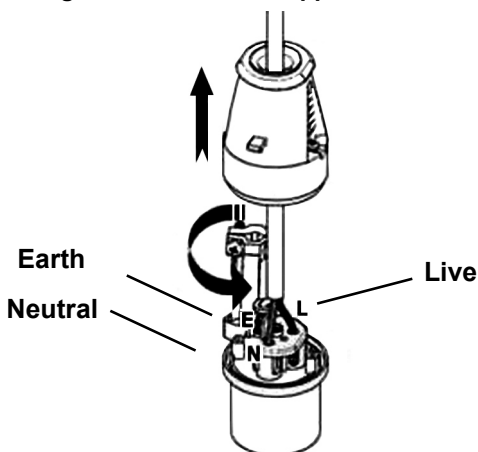

SAFETY PRECAUTIONS

1. **ALWAYS** read the manual before use.
2. Suitable for indoor use only.
3. Avoid using in dusty environments.
4. **DO NOT** use in environments containing chemical fumes etc.
5. **DO NOT** use as an extractor fan.
6. **DO NOT** use in areas of high humidity/water vapour, i.e. bathrooms etc.
7. **DO NOT** connect the fan to duct system.
8. **DO NOT** cover the fan with clothing or any material that will restrict free airflow through the fan.
9. **NEVER** touch the blades with your hand or any loose object.
10. **ALWAYS** unplug the fan before moving it or performing maintenance.
11. **DO NOT** touch the fan when your hands are wet.
12. **ALWAYS** unplug the fan when it is not in use.
13. **NEVER** unplug the fan by holding the cable. Unplug by holding the plug.
14. **NEVER** use the fan if the cable or plug are damaged.
15. **NEVER** use the fan close to fires.
16. **DO NOT** use this fan with any solid-state speed control device to reduce the risk of fire or electric shock.
17. Those who are not qualified electricians should not disassemble or repair this product.

ENVIRONMENTAL RECYCLING POLICY



Through purchase of this product, the customer is taking on the obligation to deal with the WEEE in accordance with the WEEE regulations in relation to the treatment, recycling & recovery and environmentally sound disposal of the WEEE.

In effect, this means that this product must not be disposed of with general household waste. It must be disposed of according to the laws governing Waste Electrical and Electronic Equipment (WEEE) at a recognised disposal facility.

OPERATION

Turn the switch on the speed regulator to select the fan speed required.

	CAM24110v
Position 1	879 RPM
Position 2	931 RPM

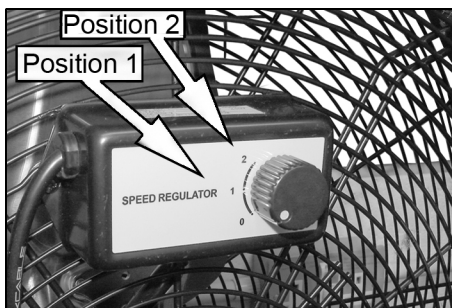

MAINTENANCE



WARNING: NEVER OPERATE THE FAN WITH THE FRONT OR REAR GUARDS REMOVED.

Have any repairs carried out by a suitably qualified person.

- The motor bearings are permanently sealed for life and do not require any additional lubrication.

If the fan has been operating for long periods in a very dusty environment, the blades and motor assembly may eventually require cleaning.

1. Disconnect the power cable from the power supply.

2. Unscrew the front guard and lift it away carefully.

3. Wipe the fan blades with dry cloth and remove any dust from the motor assembly with a soft paintbrush, vacuum cleaner or jet of compressed air.

- Always wear suitable eye protection when using compressed air.
- Never use polish or any corrosive liquid that will damage the surface finish.

4. Replace the guard securely before use.



PARTS LIST AND DIAGRAM

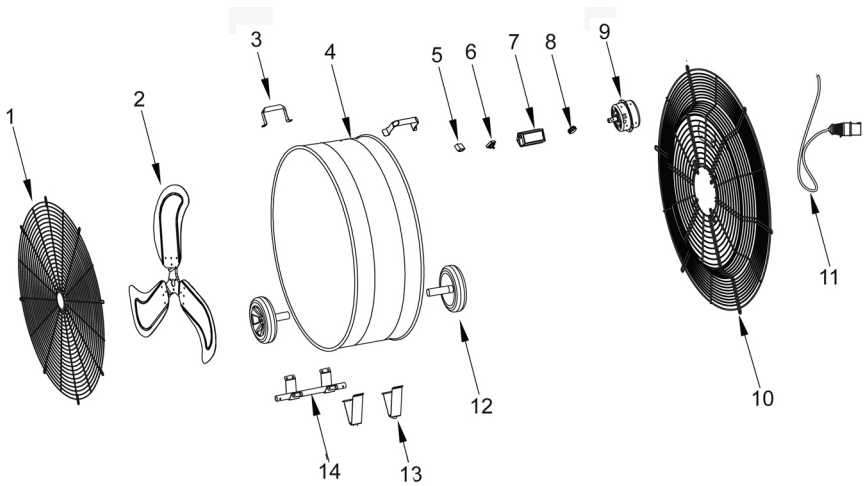

No	DESCRIPTION
1	Front Grill
2	Blade Assembly
3	Handle
4.	Drum Body
5	Capacitor
6	Switch
7	Switch Box

No	DESCRIPTION
8	Switch Knob
9	Fan Motor
10	Rear Grill
11	Power Cable
12	Wheel & Stub Axle
13	Feet
14	Axle Support

GUARANTEE

This product is guaranteed against faulty manufacture for a period of 12 months from the date of purchase. Please keep your receipt which will be required as proof of purchase.

This guarantee is invalid if the product is found to have been abused or tampered with in any way, or not used for its intended purpose.

Faulty goods should be returned to their place of purchase, no product can be returned to us without prior permission. This guarantee does not effect your statutory rights.

DECLARATIONS OF CONFORMITY





DECLARATION OF CONFORMITY
This is an important document and should be retained.

We hereby declare that this product(s) complies with the following directive(s):

- 2014/30/EU Electromagnetic Compatibility Directive.
- 2014/35/EU Low Voltage Equipment Directive.
- 2011/65/EU Restriction of Hazardous substances.

The following standards have been applied to the product(s):

- EN 61000-3-2:2014, EN 62233:2008, EN 55014-1:2017, EN 55014-2:2015,
- EN 61000-3-3:2013, EN 60335-1:2012+A11:2014+A12:2017+A1:2019+A14:2019+A2:2019,
- EN 60335-2-80:2003+A1:2004+A2:2009.

The technical documentation required to demonstrate that the product(s) meet(s) the requirement(s) of the aforementioned directive(s) has been compiled and is available for inspection by the relevant enforcement authorities.

The CE mark was first applied in: 2021

Product Description:	24", 30" 110V Drum fans
Model number(s):	CAM24110V, CAM30110V
Serial / batch Number:	N/A
Date of issue:	19/05/2021

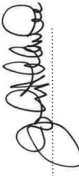
Signed: 
J.A. Clarke
Director

CAM24110V, CAM30110V Drum fans D.O.C (rev0)





DECLARATION OF CONFORMITY
This is an important document and should be retained.

We hereby declare that this product(s) complies with the following statutory requirements(s):

- Electromagnetic Compatibility Regulations 2016.
- Electrical Equipment (Safety) Regulations 2016.
- The Restriction of the Use of Certain Hazardous Substances in Electrical and Electronic Equipment Regulations 2012

The following standards have been applied to the product(s):

- EN 61000-3-2:2014, EN 62233:2008, EN 55014-1:2017, EN 55014-2:2015,
- EN 61000-3-3:2013, EN 60335-1:2012+A11:2014+A12:2017+A1:2019+A14:2019+A2:2019,
- EN 60335-2-80:2003+A1:2004+A2:2009.

The technical documentation required to demonstrate that the product(s) meet(s) the requirement(s) of the aforementioned legislation has been compiled and is available for inspection by the relevant enforcement authorities.

The UKCA mark was first applied in: 2021

Product Description:	24", 30" 110V Drum fans
Model number(s):	CAM24110V, CAM30110V
Serial / batch Number:	N/A
Date of issue:	19/05/2021

Signed: 
J.A. Clarke
Director

CAM24110V, CAM30110V Drum fans UKCA, D.O.C (rev0)

A SELECTION FROM THE VAST RANGE OF

Clarke®

QUALITY PRODUCTS



AIR COMPRESSORS

From DIY to industrial, Plus air tools, spray guns and accessories.

GENERATORS

Prime duty or emergency standby for business, home and leisure.

POWER WASHERS

Hot and cold, electric and engine driven - we have what you need

WELDERS

Mig, Arc, Tig and Spot. From DIY to auto/industrial.

METALWORKING

Drills, grinders and saws for DIY and professional use.

WOODWORKING

Saws, sanders, lathes, mortisers and dust extraction.

HYDRAULICS

Cranes, body repair kits, transmission jacks for all types of workshop use.

WATER PUMPS

Submersible, electric and engine driven for DIY, agriculture and industry.

POWERTOOLS

Angle grinders, cordless drill sets, saws and sanders.

STARTERS/CHARGERS

All sizes for car and commercial use.

PARTS & SERVICE: 0208 988 7400

Parts Enquiries
Parts@clarkeinternational.com

Servicing & Technical Enquiries
Service@clarkeinternational.com

SALES: UK 01992 565333 or Export 00 44 (0)1992 565335

Clarke® INTERNATIONAL Hemnall Street, Epping, Essex CM16 4LG
www.clarkeinternational.com